

# Open Cloud Computing Interface

An Open Specification for the Cloud Community

Thijs Metsch

[thijs.metsch@sun.com](mailto:thijs.metsch@sun.com)

Software Engineer Cloud, Grid and Virtualization

Sun Microsystems

OGF 27 – OCCl group presentation

# OGF IPR Policies Apply

- “I acknowledge that participation in this meeting is subject to the OGF Intellectual Property Policy.”
- Intellectual Property Notices Note Well: All statements related to the activities of the OGF and addressed to the OGF are subject to all provisions of Appendix B of GFD-C.1, which grants to the OGF and its participants certain licenses and rights in such statements. Such statements include verbal statements in OGF meetings, as well as written and electronic communications made at any time or place, which are addressed to:
  - the OGF plenary session,
  - any OGF working group or portion thereof,
  - the OGF Board of Directors, the GFSG, or any member thereof on behalf of the OGF,
  - the ADCOM, or any member thereof on behalf of the ADCOM,
  - any OGF mailing list, including any group list, or any other list functioning under OGF auspices,
  - the OGF Editor or the document authoring and review process
- Statements made outside of a OGF meeting, mailing list or other function, that are clearly not intended to be input to an OGF activity, group or function, are not subject to these provisions.
- Excerpt from Appendix B of GFD-C.1: “Where the OGF knows of rights, or claimed rights, the OGF secretariat shall attempt to obtain from the claimant of such rights, a written assurance that upon approval by the GFSG of the relevant OGF document(s), any party will be able to obtain the right to implement, use and distribute the technology or works when implementing, using or distributing technology based upon the specific specification(s) under openly specified, reasonable, non-discriminatory terms. The working group or research group proposing the use of the technology with respect to

“Do not worry if you do get a little bit lost. This is a talk about Cloud Computing – being lost is normal”

– Simon Wardley



# Follow the HYPE...



# How it all began





# How it all began

“If you think of standardization as the best that you know today, but which is to be improved tomorrow; you get somewhere.”

– Henry Ford

*Infrastructure as a Service*

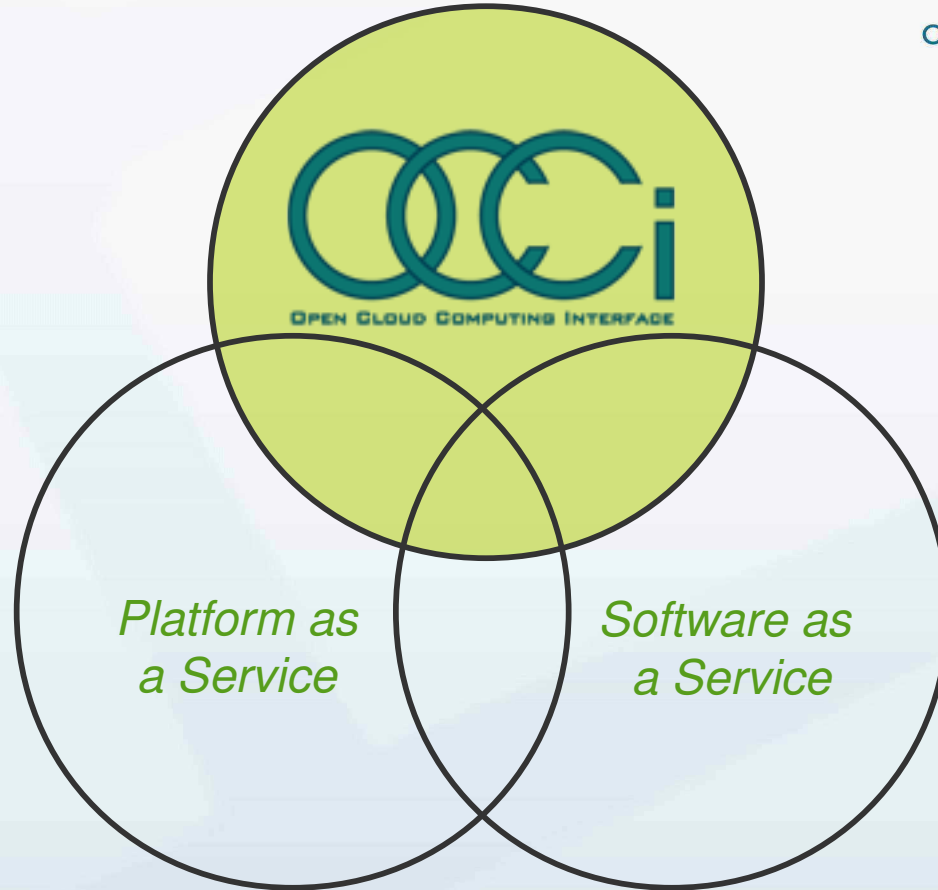

**Our focus**





# Members

**C**reate – HTTP POST

**R**etrieve – HTTP GET

**U**pdate – HTTP GET & HTTP PUT

**D**elete – HTTP DELETE

# OCCL – a quick look

*GET http://abc.com/compute/uid123foobar/*

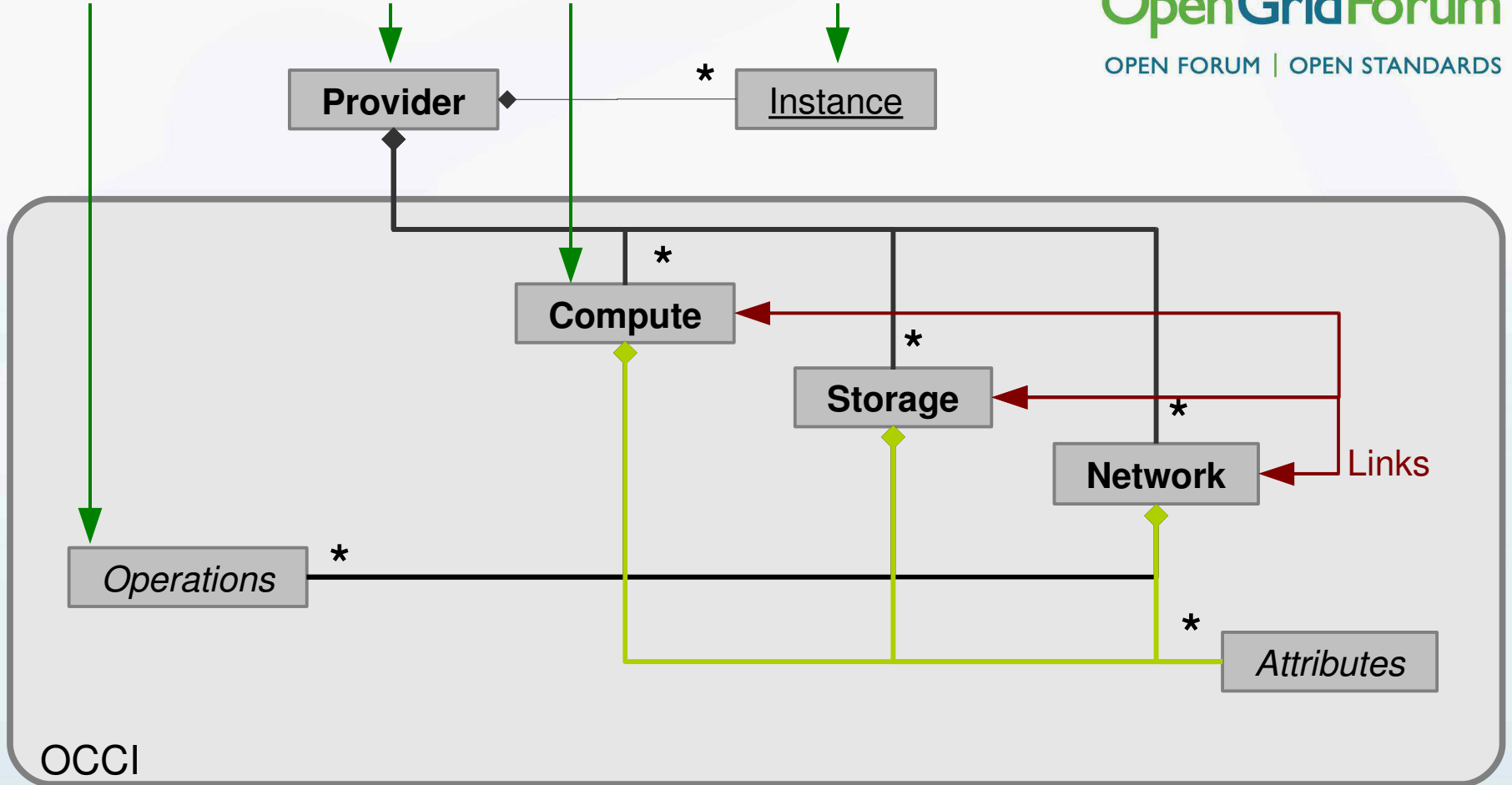

# OCCL – a second look

OCCI Groups discussions  
and presentations

Tuesday, October 13  
11:00 am - 12:30 pm

# OCCI – a third look

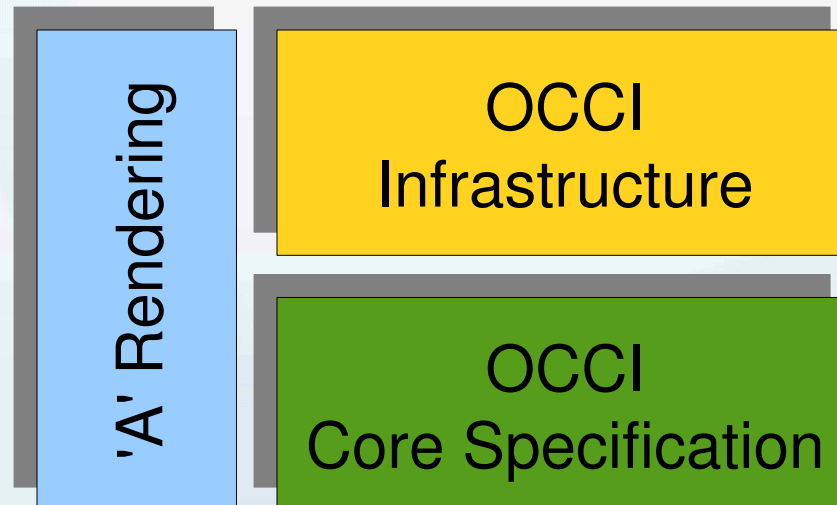

# Today

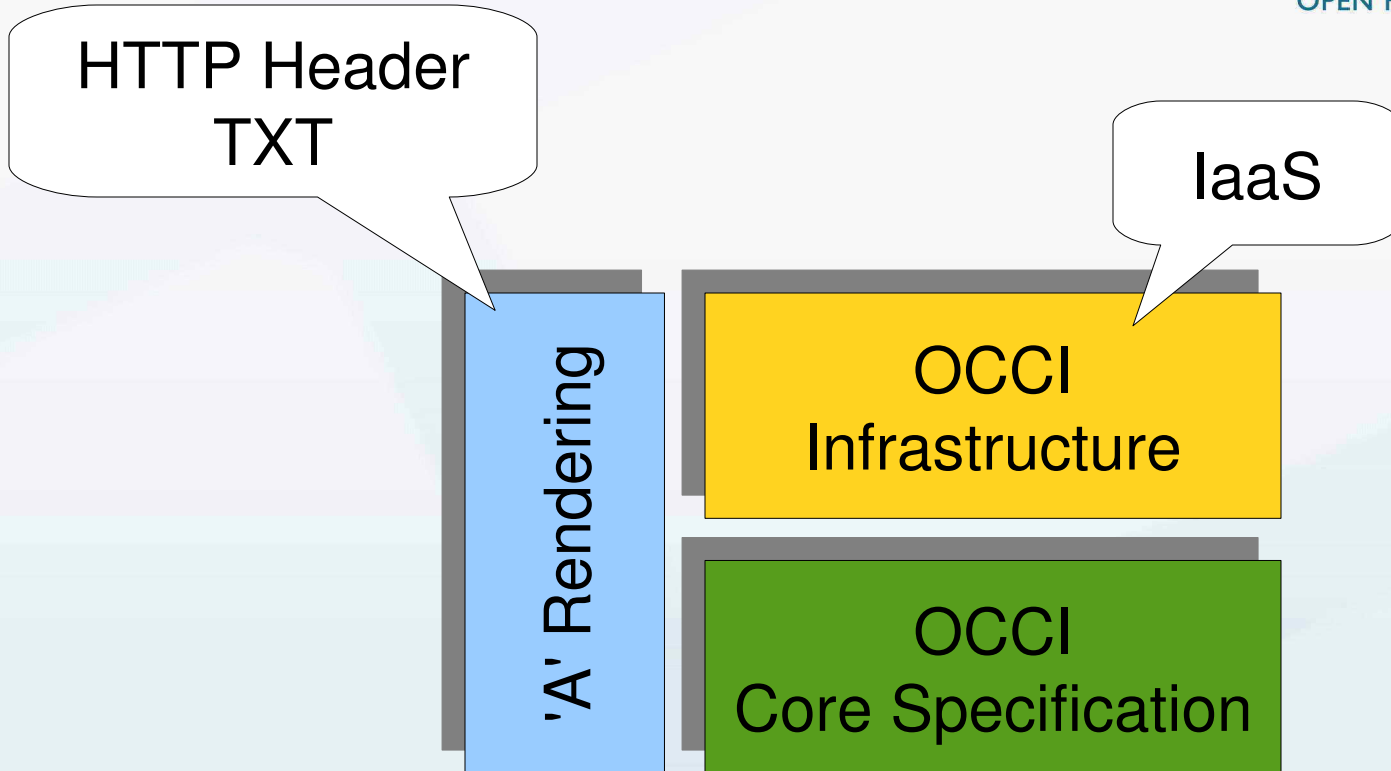

# Today



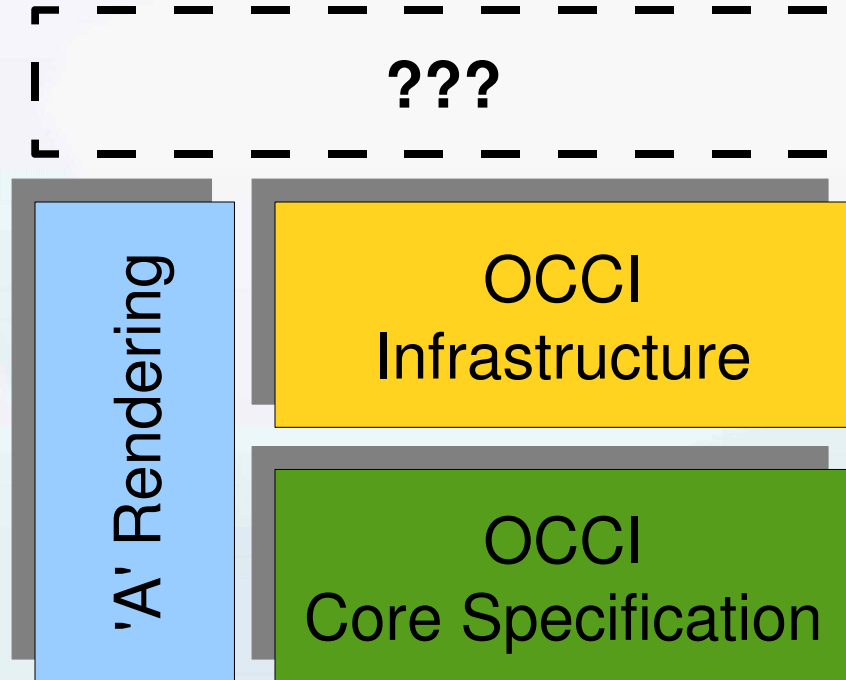

# Today

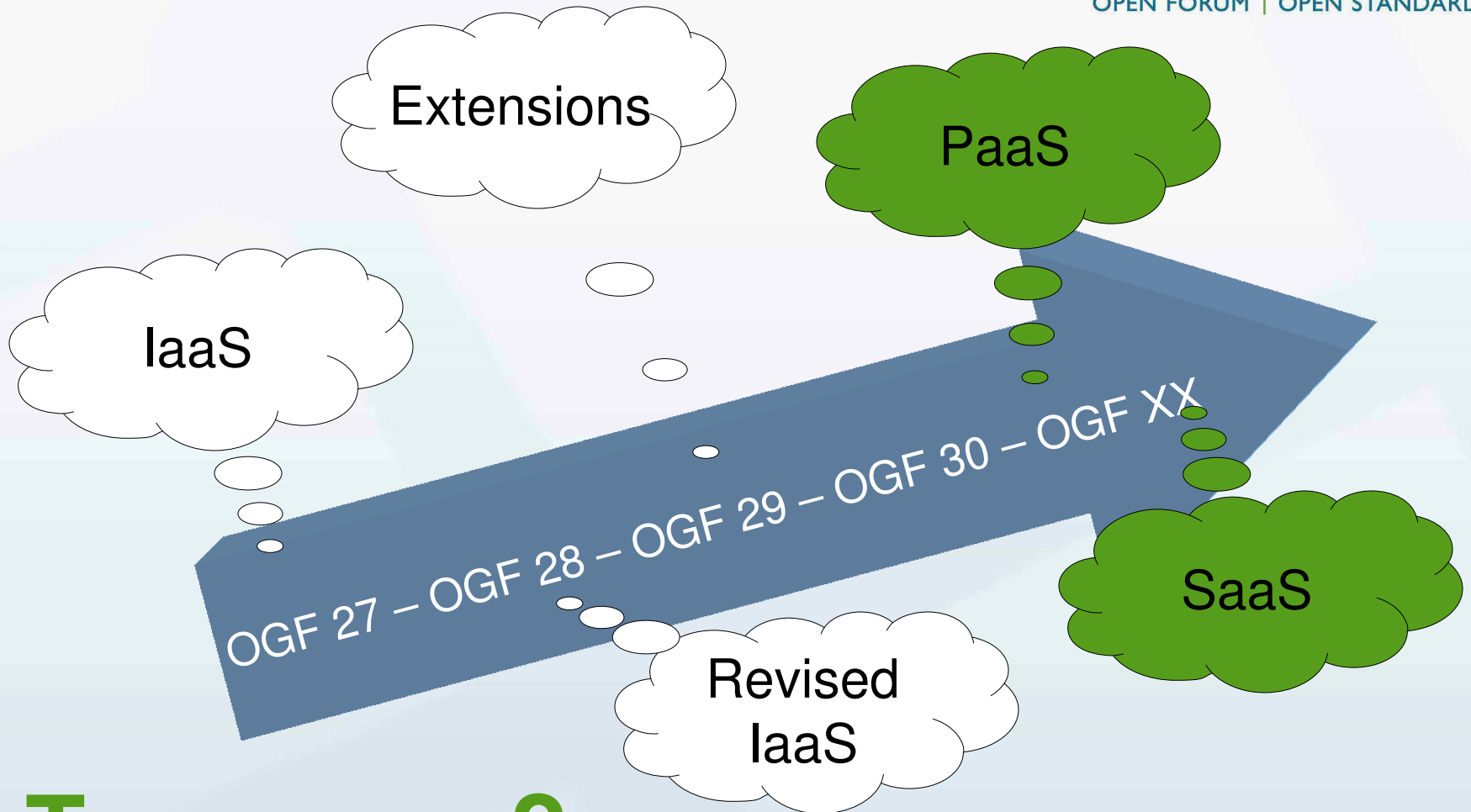

# Tomorrow?

*“OGF and Cloud Computing”*  
Craig A. Lee

*“OCCI and OpenNebula”*  
Tino Vazquez

*“INFN OCCI implementation on Grid Infrastructure”*  
Michele Orru

*“ETSI Grids, Clouds, and Service Infrastructures Event”*  
Stephan Schulz

*Cloud Computing – A perspective*  
Michael Behrens

**This session**

**NOISE TO SIGNAL**

Rob Cottingham · [socialsignal.com/n2s](http://socialsignal.com/n2s)



**At last, the fossil evidence to prove our theory! The dinosaurs died off – not because of a meteor or climate change – but because their cloud computing platform collapsed!**



**OpenGridForum**  
OPEN FORUM | OPEN STANDARDS

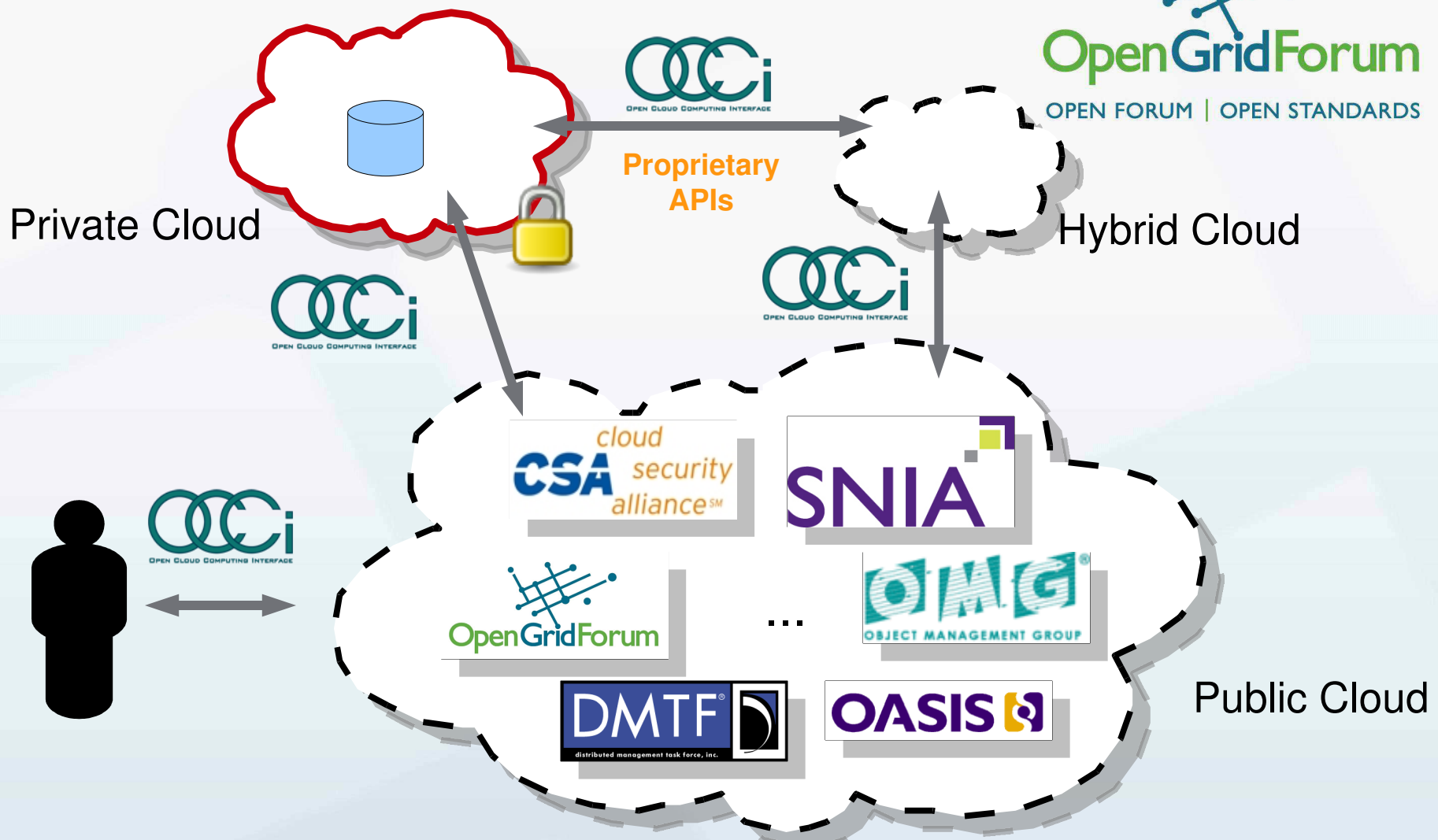

# Cloud Standards

# Full Copyright Notice



Copyright (C) Open Grid Forum (2009). All Rights Reserved.

This document and translations of it may be copied and furnished to others, and derivative works that comment on or otherwise explain it or assist in its implementation may be prepared, copied, published and distributed, in whole or in part, without restriction of any kind, provided that the above copyright notice and this paragraph are included on all such copies and derivative works.

The limited permissions granted above are perpetual and will not be revoked by the OGF or its successors or assignees.